



Advanced OCT/SLO System

RS-3000 OCT RetinaScan



The Art of Eye Care

High-Speed Scan leads to High-Quality image

High-speed scan (53,000 A-scans/s)

High-resolution image of OCT & SLO

Extremely easy and fast operation with optimization

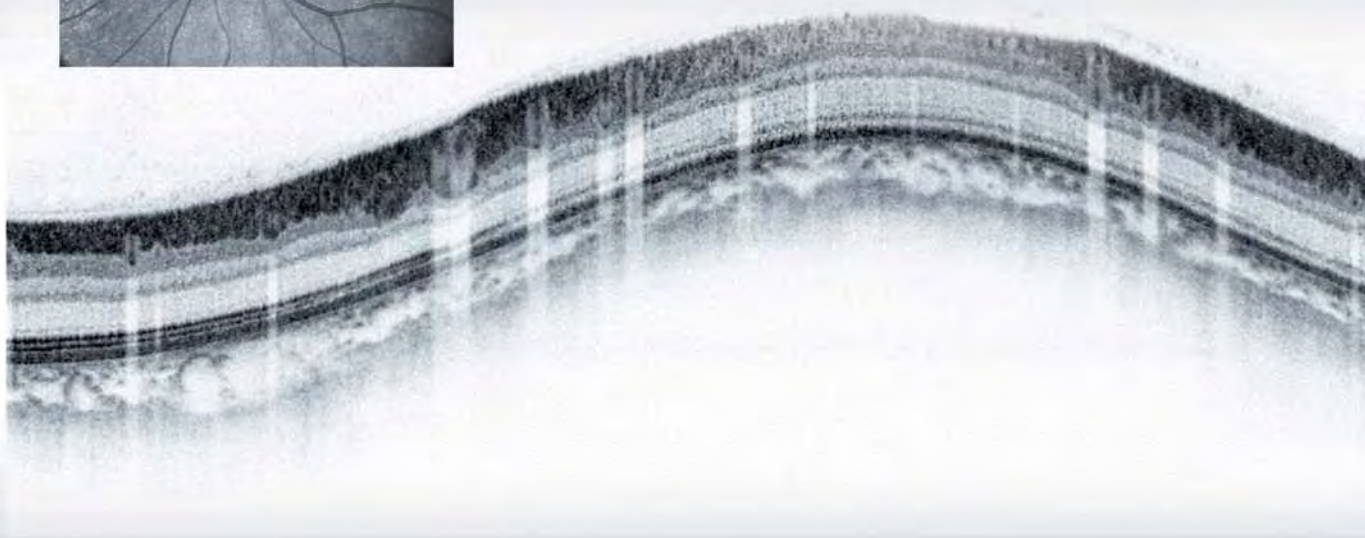
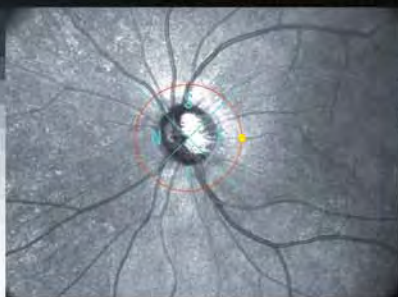
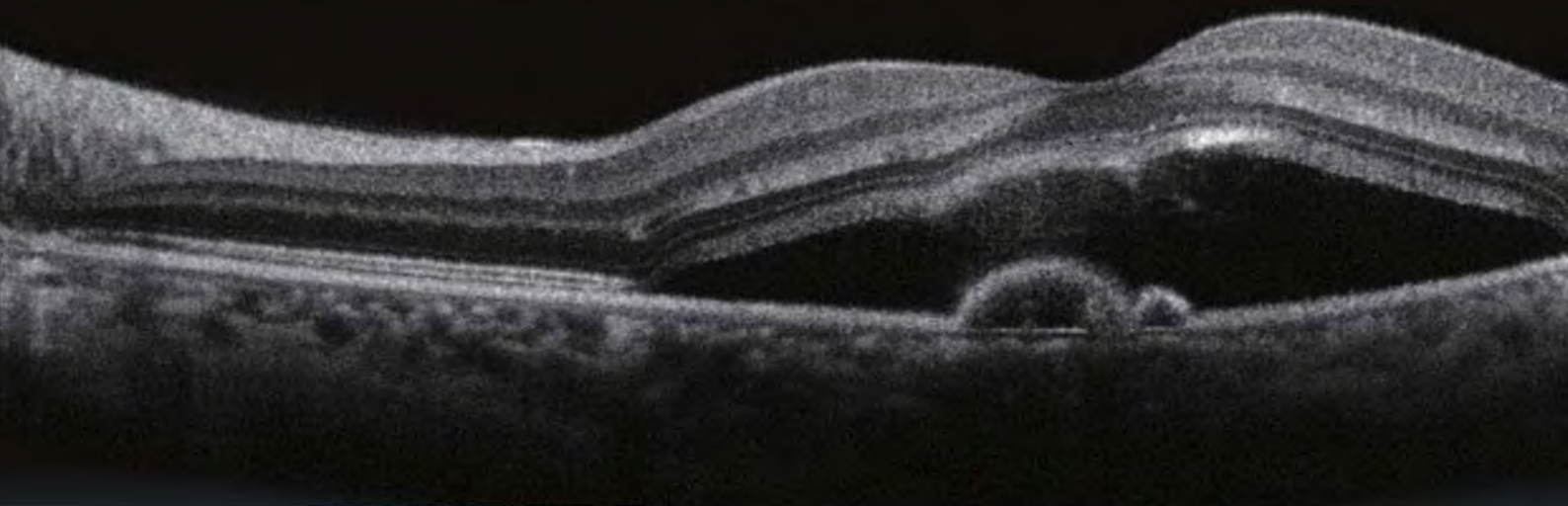

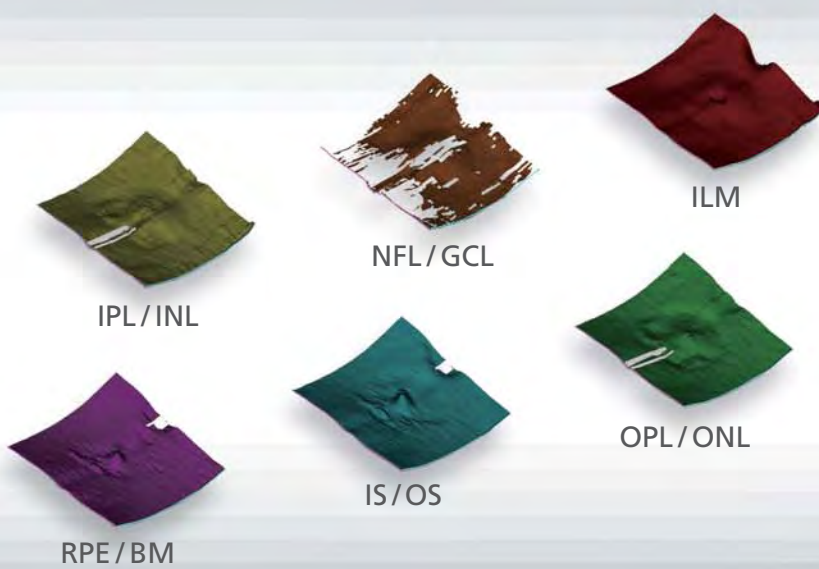
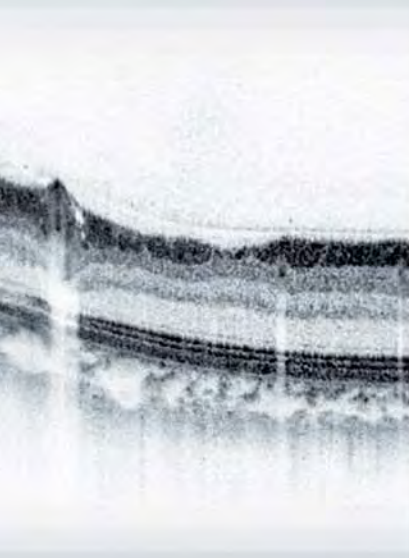
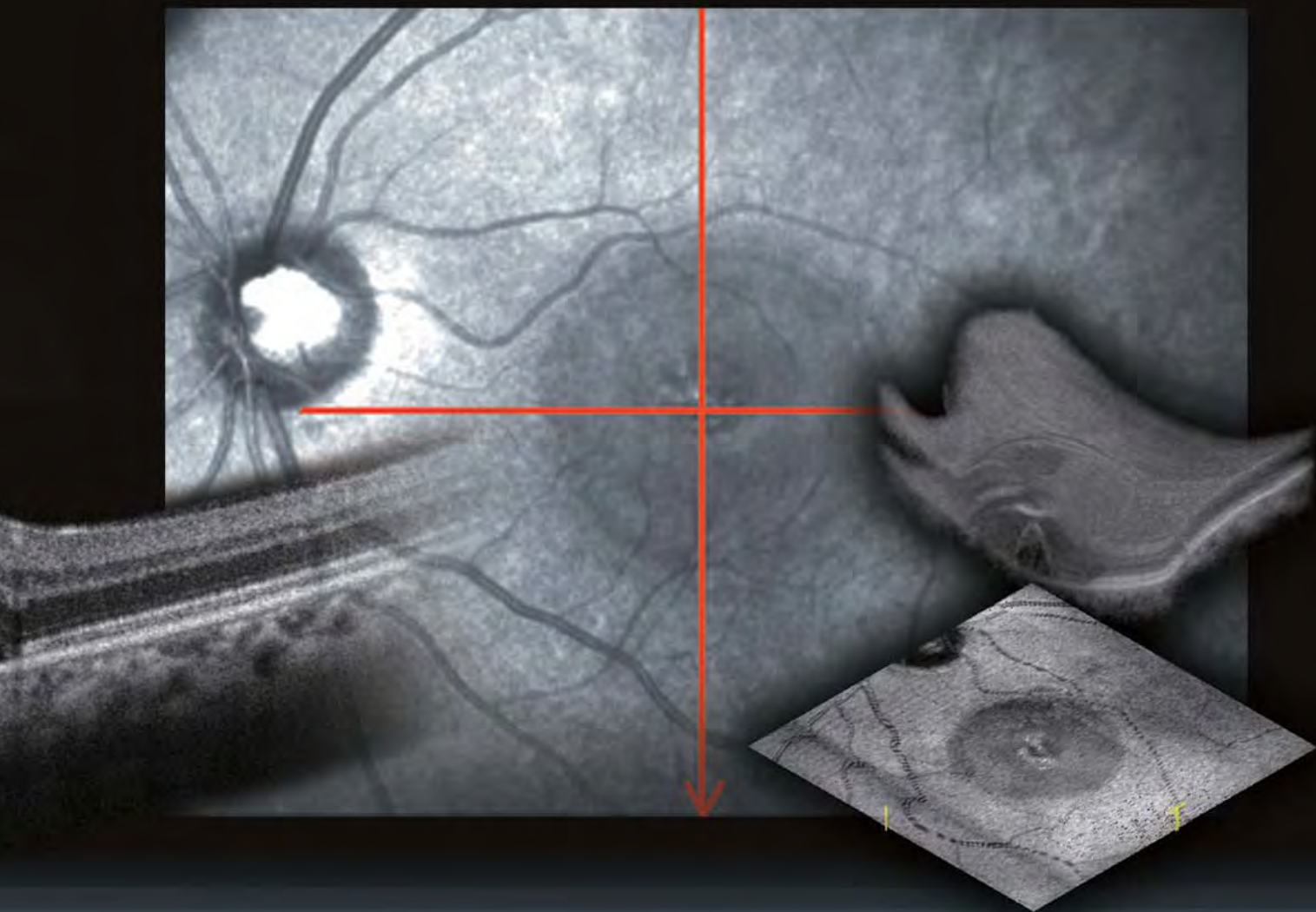

NIDEK is proud to announce its first release of advanced spectral domain OCT / confocal ophthalmoscope system, RS-3000 OCT "RetinaScan". The RS-3000 is a high-speed spectral domain OCT with the tradition of NIDEK, advanced auto-focus / auto Z alignment technology offering the combination of Precision and Ease-of-Use.

High-speed (53,000 A-scans/s) & High-quality image (4 μm OCT digital resolution)

53,000 A-scans / s greatly helps to reduce the measurement time and minimize artifacts. The advanced speckle-noise-reduction system by averaging images provides 4 μm OCT digital resolution. High-resolution image shows the discrete retinal layers.



Max. 50 image averaging

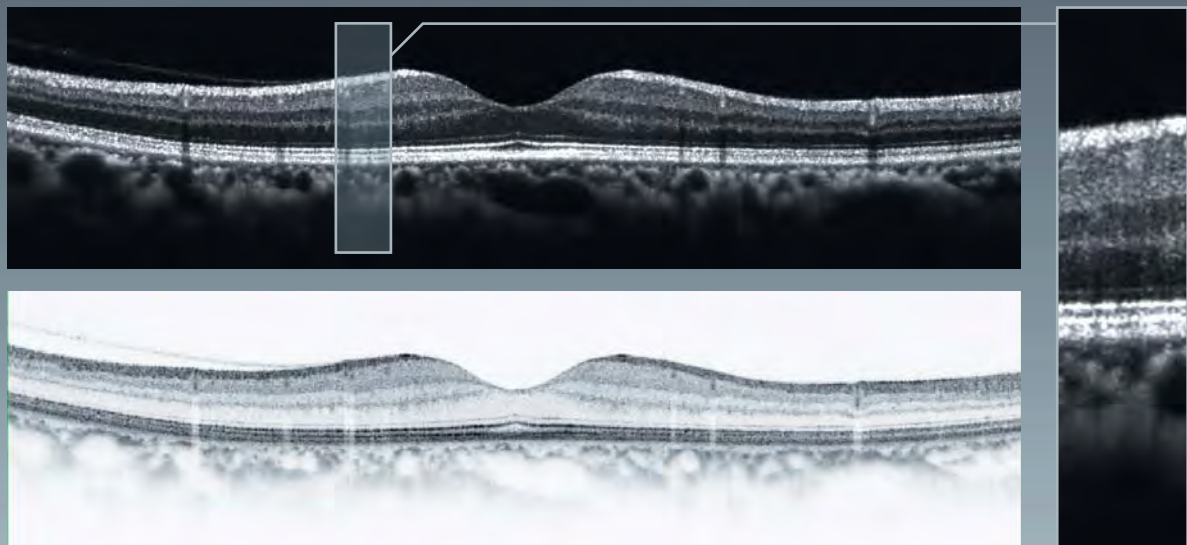

Accurate localization of pathology with real-time SLO image

Real-time, high-contrast and wide view (40° x 30°) of confocal SLO imaging offers the accuracy for OCT scanning of the pathological target. OCT scanning position is precisely matched with SLO fundus image.

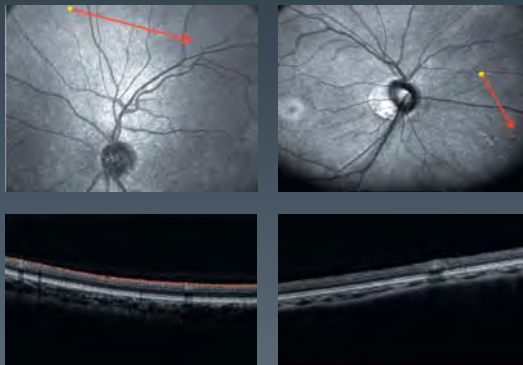
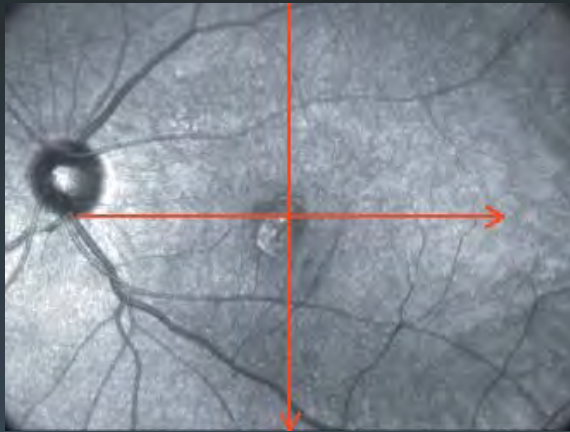

The position, length, angle of scanning line for the target are easily and flexibly changed on real-time confocal SLO image.

Fast and simple operation with optimization

The operation of RS-3000 is as easy as Auto-Refractometer. The focus of SLO fundus image and the alignment of OCT depth are adjusted automatically by pressing optimization button.



1 Start Scanning

2 Optimization

The focus of SLO fundus image and the alignment of OCT depth are adjusted automatically.

3 Release

Capturing both image of SLO and OCT by one shot.

The RS-3000 provides 6 types of useful OCT scans to meet clinical requirements.

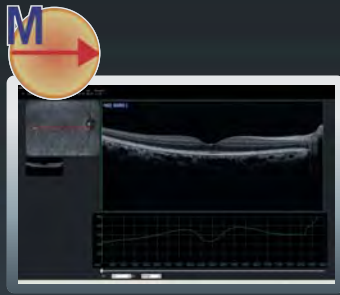

Macula line



Macula cross

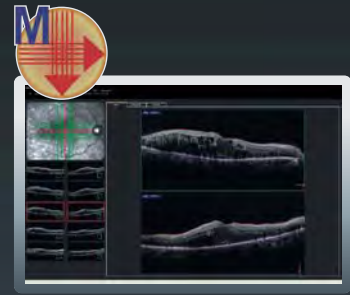

Macula multi

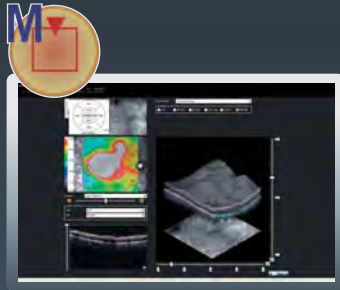

Macula map

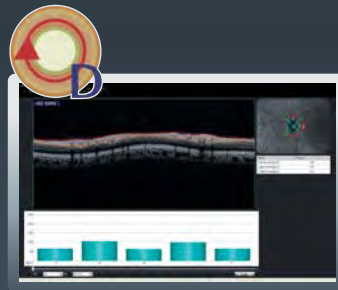

Disc circle

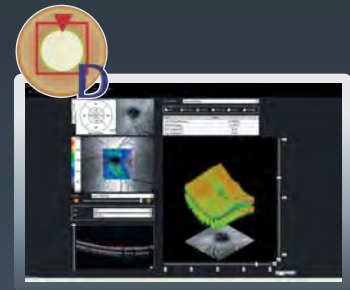

Disc map

Highly reproducible follow-up examination with auto-tracking function

High contrast SLO fundus image and auto-tracking function achieve excellent reproducibility in follow-up examination. Auto-tracking function tracks eye movement and guides the OCT scanning to the previous examination position. Time frame monitoring results of examinations including NFL defect, Optic nerve head and macular thickness can be conducted easily.

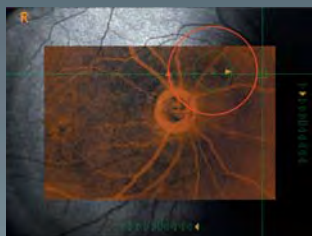

Not match with baseline

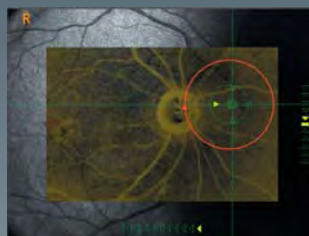

Relatively match with baseline

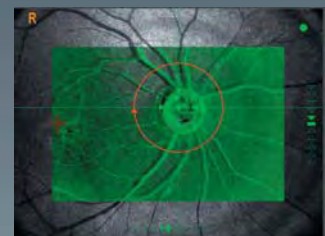

Match with baseline

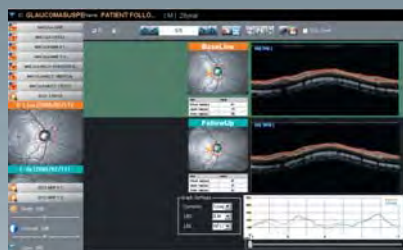

Disc circle

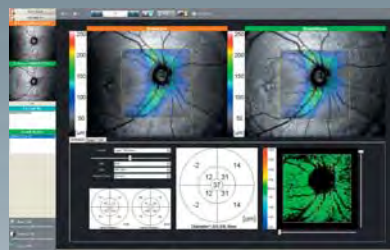

Disc map

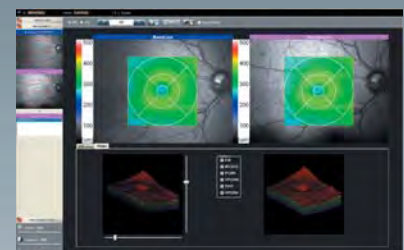

Macula map

High-speed (1.6 s) and wide (9 mm x 9 mm) 3D mapping

High-speed and wide 3D imaging help to understand retinal condition quickly and comprehensively. Thickness map between each layer from ILM to RPE can be available.

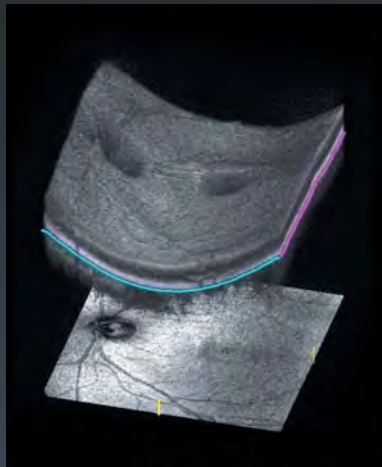

Layer thickness map

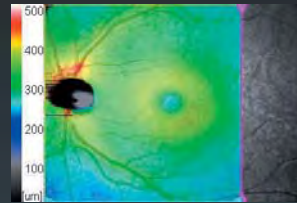

ILM - RPE/BM

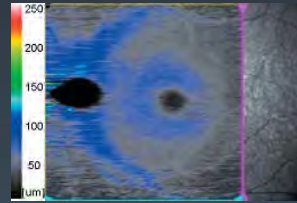

ILM + NFL + GCL + IPL

6 Layer Segmentation

The morphological change on the surface of each layer is visually confirmed.

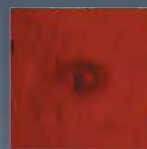
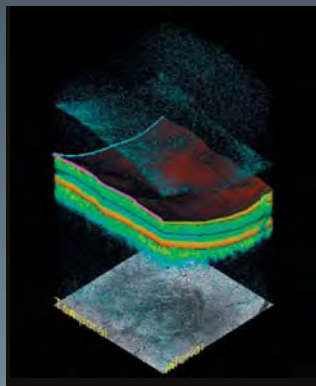

ILM

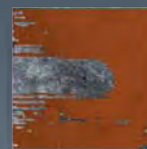

NFL / GCL

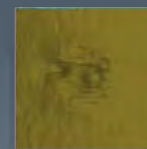

IPL / INL



IS / OS

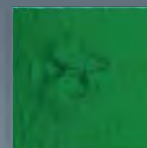

OPL / ONL



RPE / BM

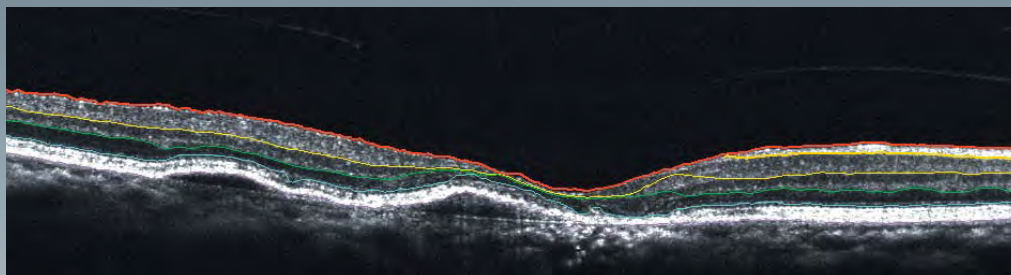

Clinical Images

High-quality images can be taken in actual pathological cases.

Myopic retinoschisis

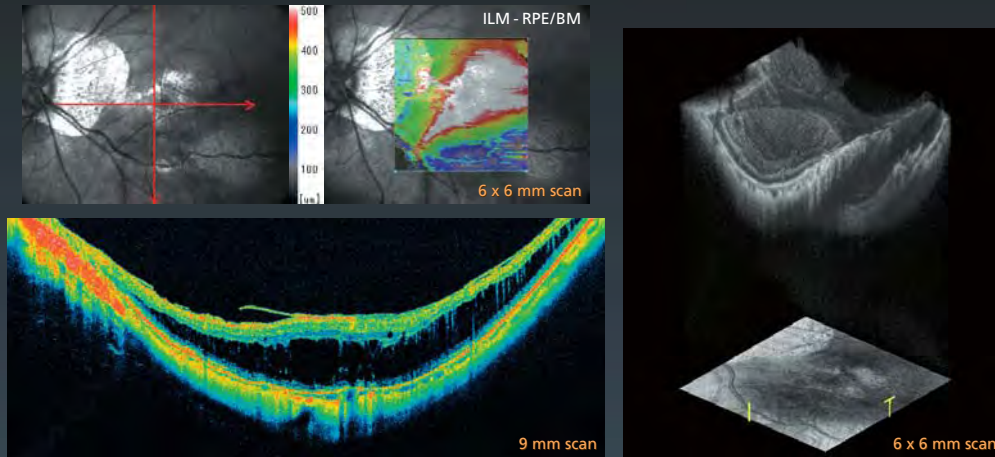

Age-related macular degeneration (AMD)

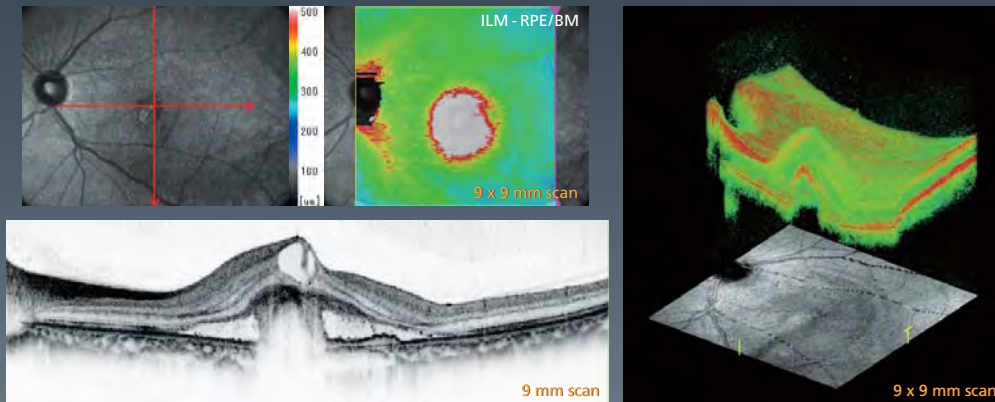

Polypoidal choroidal vasculopathy (PCV)

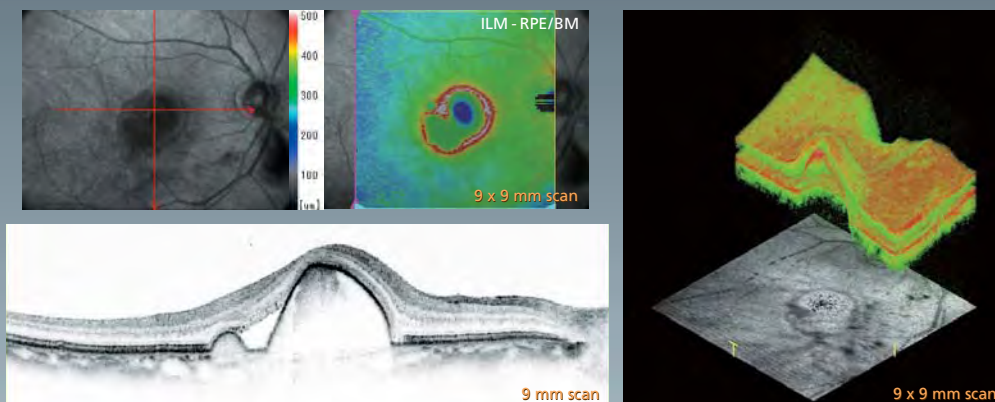

Pseudo macular hole

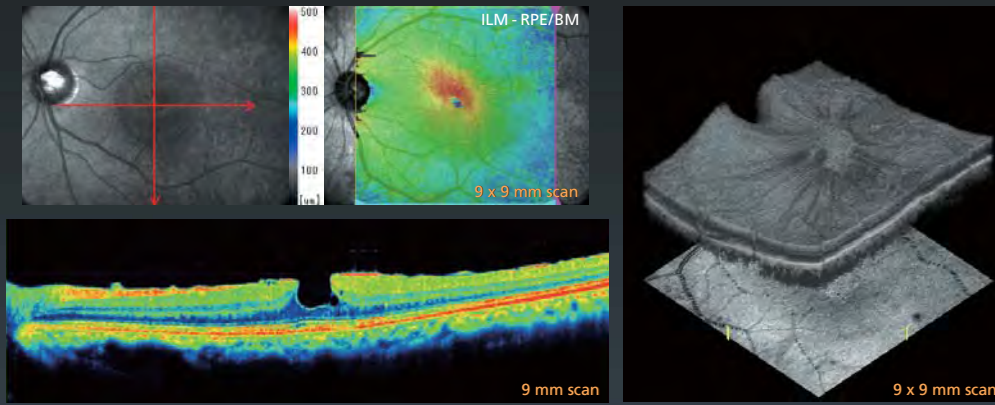

Epiretinal membrane (ERM)

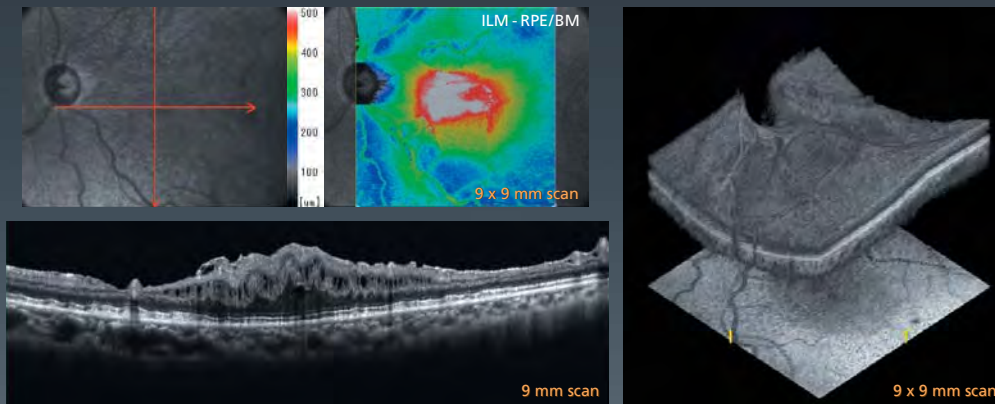

Vogt-Koyanagi-Harada disease

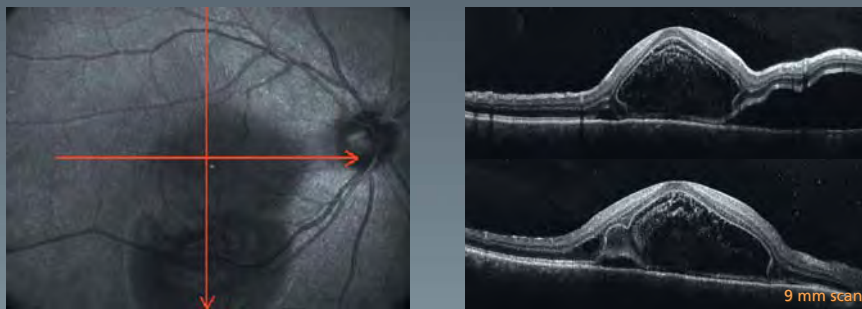

Glaucoma

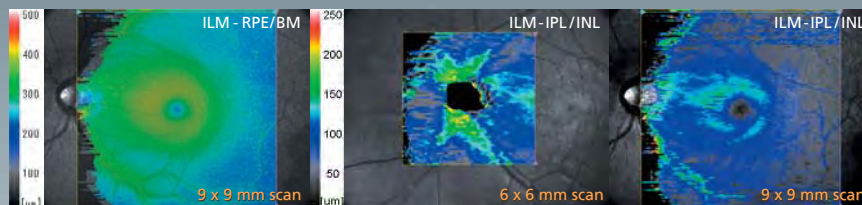



The NAVIS-EX Image Filing Software is included in any package of the RS-3000 OCT "RetinaScan" System.

As well as filing, manipulating and analyzing the images from the RS-3000, NAVIS-EX is able to import the images from various external instruments.

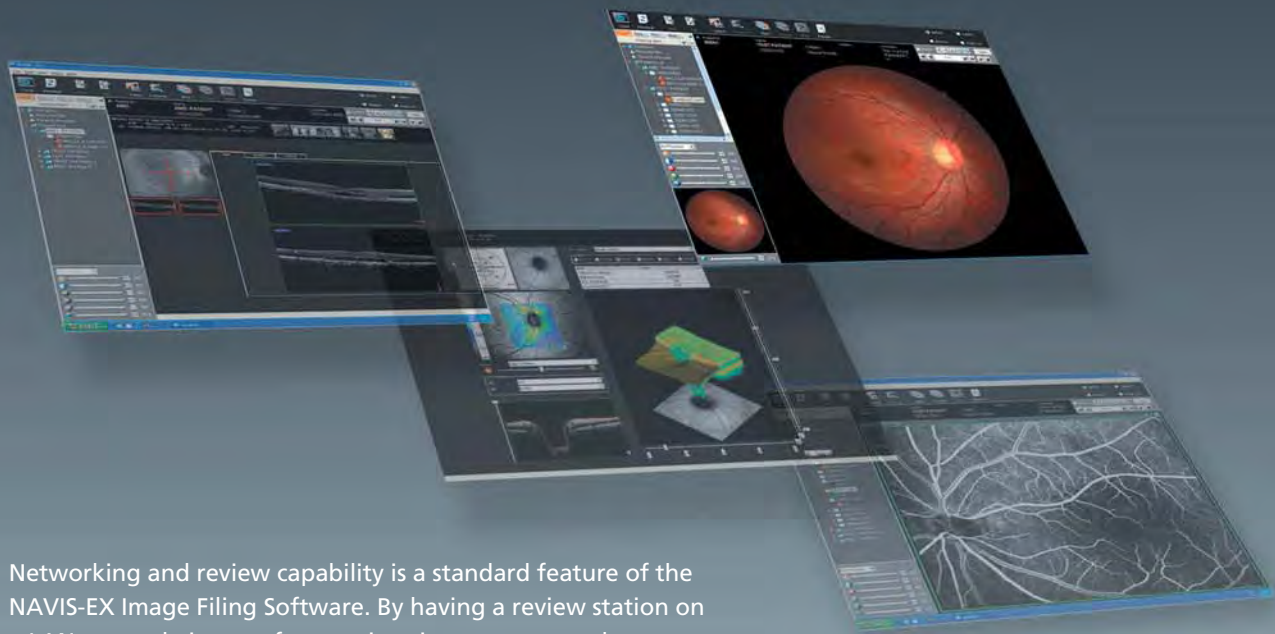

Networking and review capability is a standard feature of the NAVIS-EX Image Filing Software. By having a review station on a LAN network, images from various instruments can be managed within unified software network on a single PC.

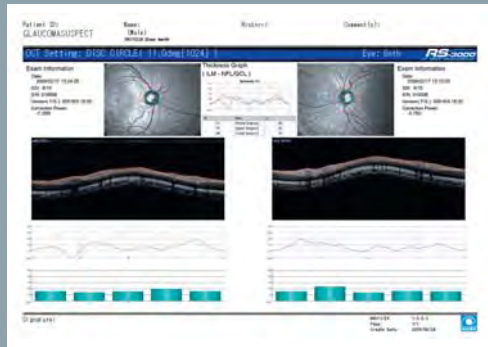

RNFL thickness analysis report

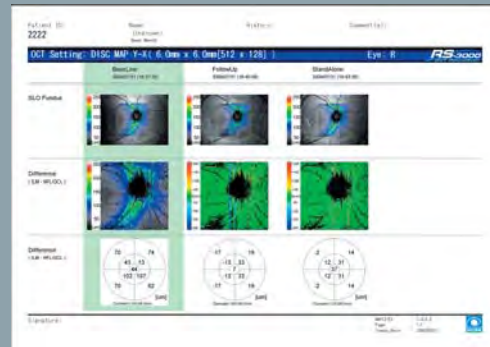

Follow-up examination of RNFL thickness report

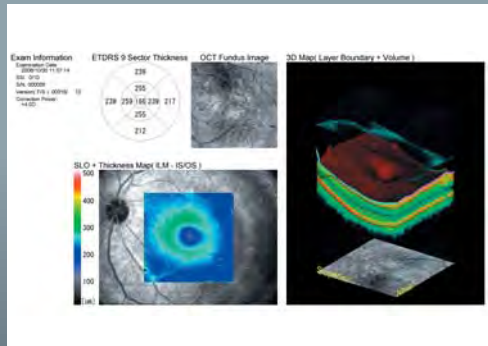

Macular thickness (ILM - IS/OS) report

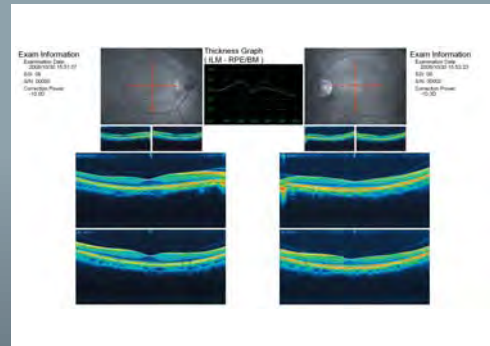

Macular thickness (ILM - RPE/BM) analysis report

Numerous kinds of reports can be printed from the NAVIS-EX Image Filing Software, including side-by-side comparison and follow up in comparison to baseline image.



RS-3000 Specifications

OCT scanning	
Technology	Spectral domain OCT
OCT resolution	Optical Z: 7 μ m, XY: 20 μ m Digital Z: 4 μ m, XY: 3 μ m
Scanning range	Z: 2.1 mm XY: 3 to 9 mm
OCT light source	SLD, 880 nm
Scanning speed	53,000 A-scans / s
Acquisition time of 3D image	1.6 s
Internal fixation lamp / Wavelength	Cross shape (normal or large) / 635 nm
External fixation lamp	Red / Green
Auto alignment	Z direction
Minimum pupil diameter	ϕ 2.5 mm
Focus adjustment range	-15 to +10 D (VD= 12 mm)
Working distance	35.5 mm (from the objective lens to the pupil)
Scanning pattern	Macula line (scan angle changeable by 15°) Macula cross Macula map Macula multi (X - Y: 5 x 5) Disc circle Disc map
Software analysis	
	Segmentation of 6 retinal layers Macular thickness map RNFL thickness map Optic nerve analysis Follow-up examination of pathological progress
SLO imaging	
Technology	Confocal scanning laser ophthalmoscope
SLO light source	785 nm
Field of view	40° x 30° (zoom: 20° x 15°)
Focusing method	Auto focus
PC networking	Available
Display	Tiltable 8.4-inch color LCD
Power supply	AC 100, 120, 230 V \pm 10% 50 / 60 Hz
Power consumption	300 VA
Maximum power output (transformer)	1000 VA
Dimensions / Weight	380 (W) x 524 (D) x 499 to 531 (H) mm / 34 kg 14.96 (W) x 20.63 (D) x 19.65 to 20.91 (H)" / 75.0 lbs.

Motorized optical table (optional)

Dimensions / Weight	592 (W) x 472 (D) x 596 to 794 (H) mm / 27 kg 23.31 (W) x 18.58 (D) x 23.46 to 31.26 (H)" / 59.5 lbs.
Power supply	AC 100 V 50 / 60 Hz
Power consumption	150 W

PC rack (optional)

Dimensions / Weight	632 (W) x 452 (D) x 703 (H) mm / 34 kg 24.88 (W) x 17.80 (D) x 27.68 (H)" / 75.0 lbs.
---------------------	--

Footprint (mm)

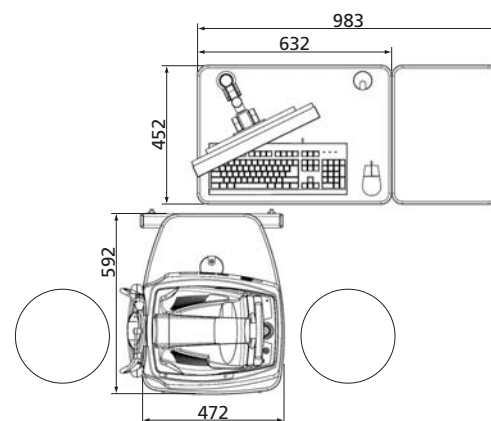

FDA 510(K) pending

Specifications and design are subject to change without notice.



HEAD OFFICE

34-14 Maehama, Hiroishi
Gamagori, Aichi, 443-0038, Japan
Telephone: +81-533-67-6611
Facsimile: +81-533-67-6610
URL: <http://www.nidek.co.jp>

[Manufacturer]

TOKYO OFFICE

(International Div.)
3F Sumitomo Fudosan Hongo Bldg.,
3-22-5 Hongo, Bunkyo-ku, Tokyo,
113-0033, Japan
Telephone: +81-3-5844-2641
Facsimile: +81-3-5844-2642
URL: <http://www.nidek.com>

NIDEK INC.

47651 Westinghouse Drive
Fremont, CA 94539, U.S.A.
Telephone: +1-510-226-5700
+1-800-223-9044 (US only)
Facsimile: +1-510-226-5750
URL: <http://usa.nidek.com>

NIDEK S.A.

Europarc
13, rue Auguste Perret
94042 Créteil, France
Telephone: +33-1-49 80 97 97
Facsimile: +33-1-49 80 32 08
URL: <http://www.nidek.fr>

NIDEK TECHNOLOGIES Srl

Via dell'Artigianato, 6 / A
35020 Albignasego (Padova), Italy
Telephone: +39 049 8629200 / 8626399
Facsimile: +39 049 8626824
URL: <http://www.nidektechnologies.it>

