

OCULUS Keratograph 4 Topographer



OCULUS Keratograph 4

From a measuring instrument to a consultation tool

Gold standard corneal topography – that's what the Keratograph 4 is all about. It ensures reliability when it comes to taking measurements, providing consultation and fitting contact lenses. The Keratograph generates findings you can build on. The integrated keratometer and automatic measurement activation guarantee perfect reproducibility. In this way, the Keratograph 4 also meets highest clinical standards for such procedures as tear film assessment and qualitative cornea analysis. It stands out by virtue of its versatility.

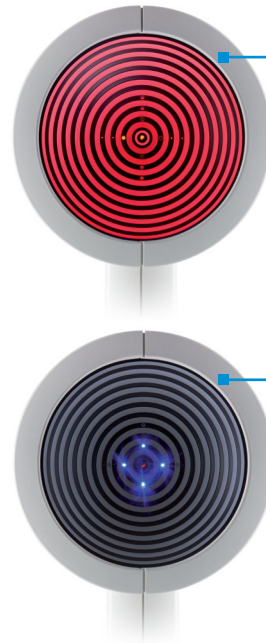

Taking Measurements with Placido Ring Illumination

The cornea is represented across its entire surface and globally using thousands of measuring points. Precise measurements form the basis for many modes of analysis and representation, such as automatic keratoconus detection and 3D representation of the cornea.

Taking Measurements with the Blue Light Emitting Diode

Previously you may have taken static fluo images and videos using the slit lamp – now you can also do so with the Keratograph 4! Use this function to examine the fit and mobility of contact lenses.

Precise Measurements, Comprehensible Presentation – A Picture Says More Than a Thousand Words

Use the Keratograph 4 as a marketing tool and incorporate it actively into your consultations. With the Keratograph 4 software you can show images which your patients have never seen before. Competent consultation (e.g. during follow-up exams) builds trust and forms the basis for intensive patient loyalty. The Keratograph 4 – not only a measuring instrument but also an ideal marketing tool.

Diagnostics

Early detection is key to preserving vision

Fast Non-contact Measurements

Hygiene and time management are important for any successful ophthalmic practice.

Precise and Reliable Diagnosis and Follow-up

The Keratograph 4 produces accurate measurements that help to detect changes on the corneal surface at an early stage. Long-term follow-up is essential when dealing with corneal changes.

Corneal Surgery

The Keratograph 4 provides reliable pre- and postoperative measurements.

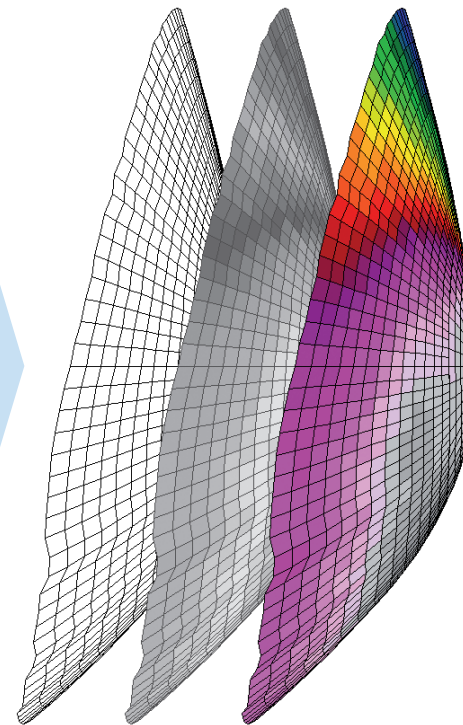
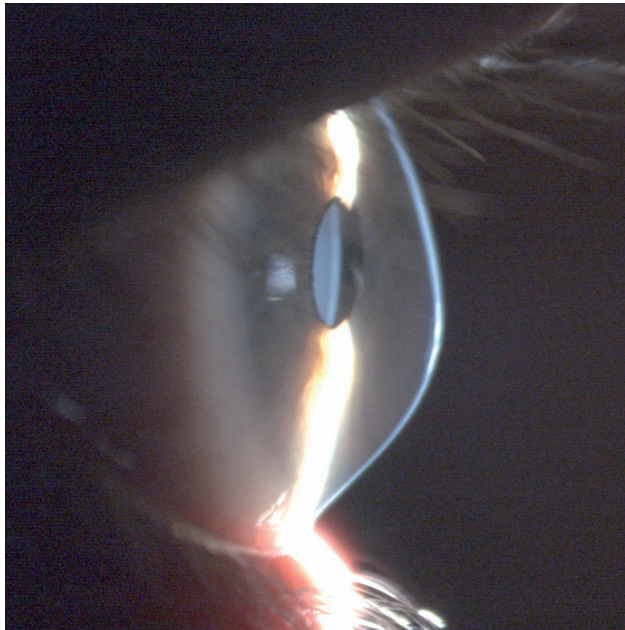

Over 25 years of experience in assessing topographic measurements.

Topography

High-performance functionality, easy-to-grasp displays

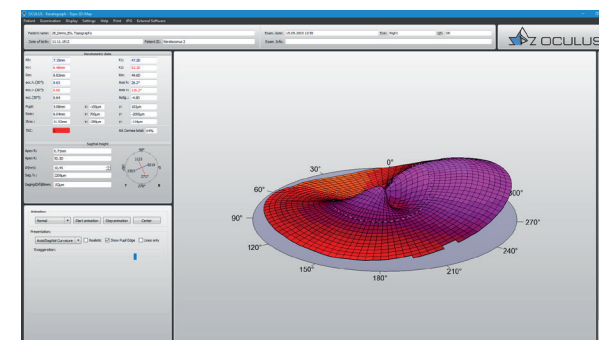
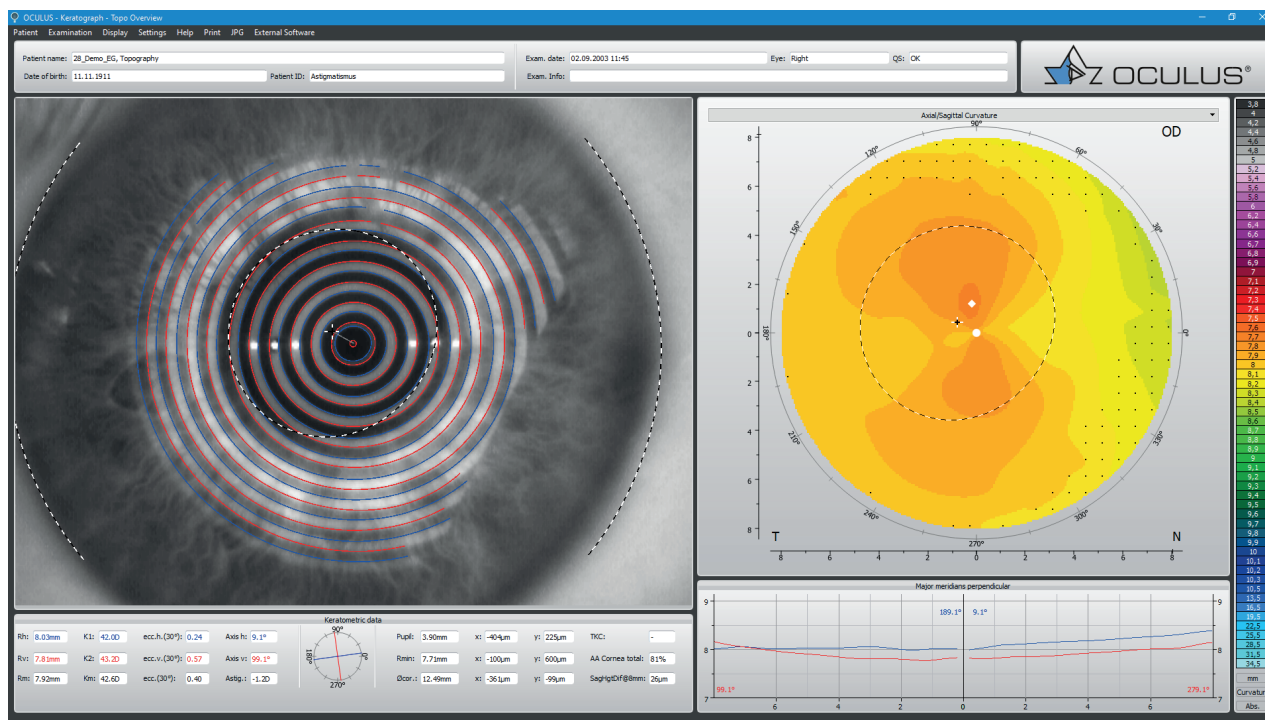

3D Display

The 3D display depicts the curvature of the cornea. Any corneal astigmatism and irregularities can be demonstrated in an easy and comprehensible way. By swivelling and rotating the 3D map, the cornea can be viewed from various perspectives. Abnormalities can be displayed easily, which helps with patient consultation.

Overview Display

The integrated keratometer guarantees highest measurement precision and reproducibility. After measurements have been taken, the comprehensive overview display mode gives you a fast overview. Among other parameters, the central radii, K values, corneal astigmatism, eccentricity and corneal curvature are displayed. The colour topographic maps depict the curvature of the anterior corneal surface. Irregularities can be seen and measured on the camera image.

Detailed Display of the Cornea

The Keratograph software includes a reliable screening package for corneal disease detection, lens fitting and refractive surgery. The complex surface structure of the cornea is measured, allowing accurate detection of irregularities such as keratoconus. In addition, the optical properties of its front surface are characterized precisely, applying several mathematical analyses (i.e. Fourier or Zernike Analysis).

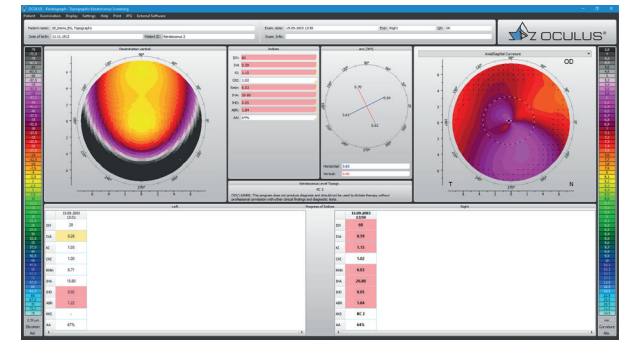
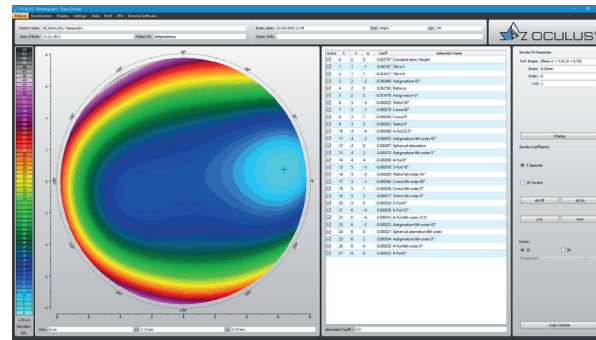
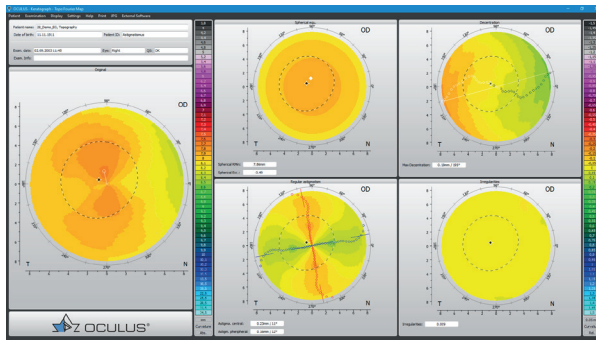

Complete Documentation

Follow-ups provide reliability

Follow-ups require comparison of several examinations, so that changes may be easily detected and fully documented. Regular follow-up examinations provide reliability, cultivating a relationship of trust between you and your patient. The Keratograph software includes both data and image documentation.

Compare 4 Exams

With this feature you can compare up to four examinations. Changes from the first to the latest measurement can easily be displayed, reflecting the course of disease over time. Select the examinations you wish to compare (A, B, C, D) with only two clicks and see the results right away, independent of the curvature type.

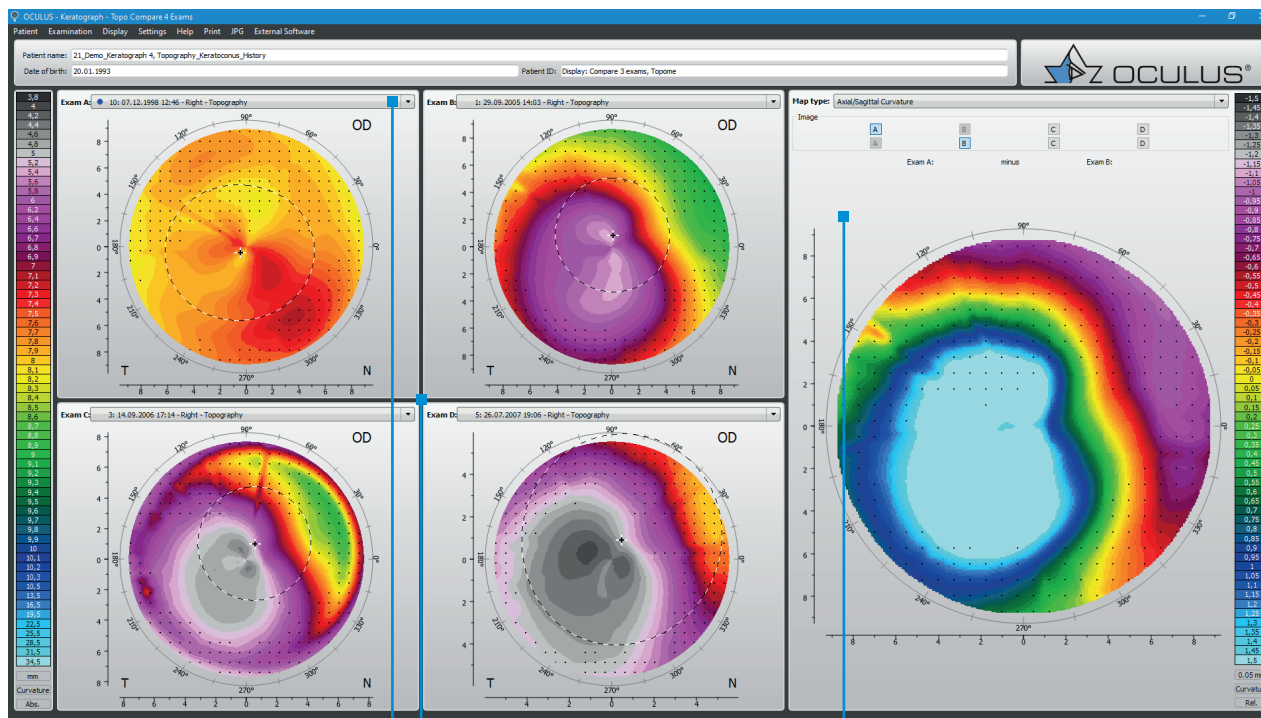

Selection of examination from the patient data base

"Course of Disease" display showing four examinations

Graphic display of differences between individual examinations. Display as axial/sagittal or tangential curvature, elevation data or refractive power.

Corneal Changes – Easy to Grasp from Different Perspectives

No matter whether caused by keratoconus, refractive surgery or an inaccurate contact lens fit, corneal changes are a serious matter and should therefore be checked for regularly. The Keratograph's possibilities of comparing results and visualizing corneal progression are also helpful tools for patient education and documentation.

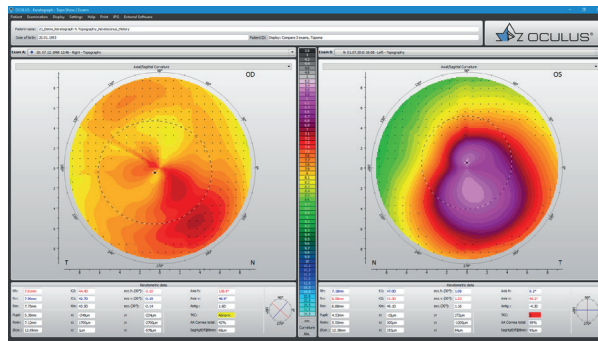

Show 2 Exams

During follow-up examinations, it is necessary to compare the results with previous exams. With this feature you can compare changes over time in corneal topography in contact lens wearers as well as patients with a progressive condition, such as keratoconus.

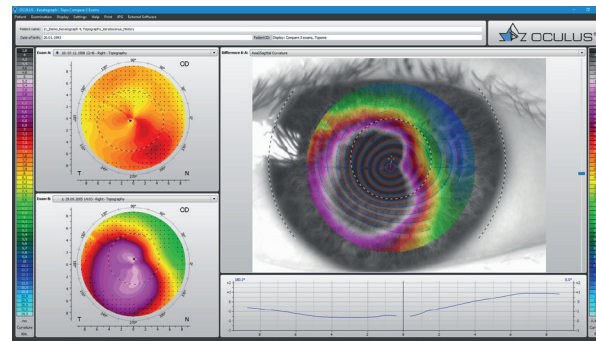

Compare 2 Exams

Comparing two examinations allows to follow dioptric changes along a selected meridian. The colour map overlay provides a better understanding of corneal influence compared to the pupil size.

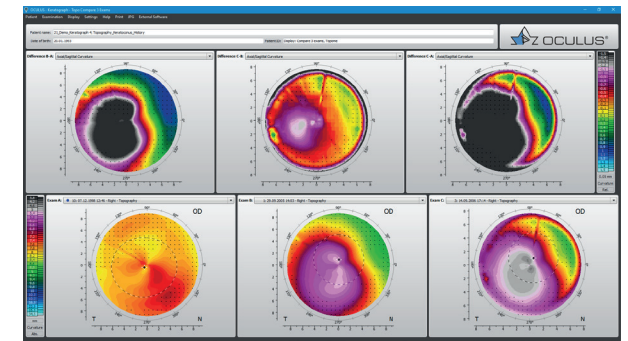

Compare 3 Exams

With this feature, up to 3 examinations can be displayed and compared side by side. This is very useful in follow-up examinations and in assessing progression or changes in your patients' eye health.

Contact Lens Fitting

Professionalism through innovation

Contact lenses are recommended on an individual basis and displayed in a list. In order to avoid taking more steps than necessary when fitting contact lenses, the fluo image can be simulated beforehand. The contact lens can be rotated and moved around. Fluo image simulation is adjusted automatically. The integrated and expandable database contains all customary types of contact lenses and is updated on a regular basis. The user can determine the order in which contact lens manufacturers appear.

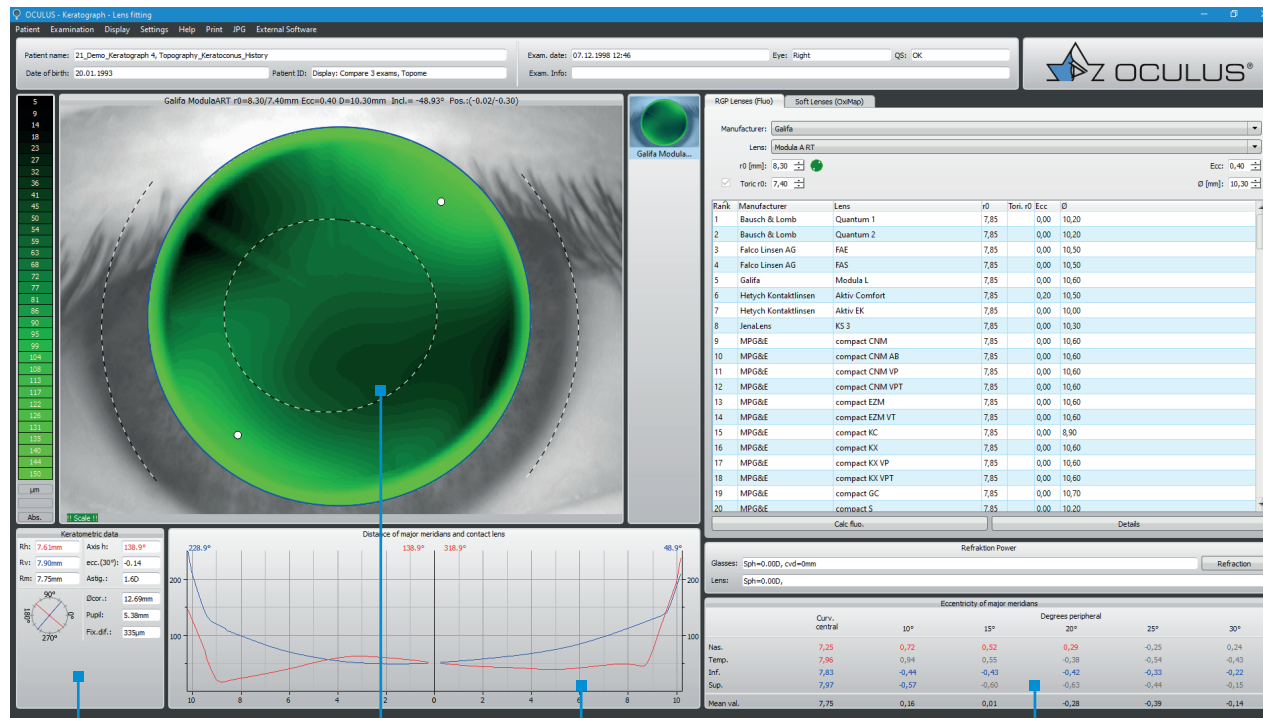

Keratometric data, diameter of the cornea and pupil, fixation deviation

Simulated fluorescein image of a toric RGP lens

Distance of major meridians of the cornea from the lens

Eccentricity values for both major meridians

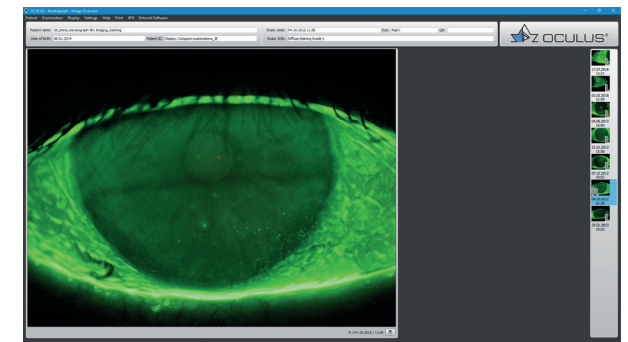

Imaging

Using the "Imaging" option, real fluo images and videos are recorded – similar to the way images can be seen with a slit lamp using fluo drops. In this way you can check and demonstrate the fit and mobility of contact lenses to patients. All images and videos as well as suggested contact lens fits are saved automatically

The Keratograph 4 provides all you need for this:

- blue light emitting diodes in the illumination beam path
- a yellow filter in the observation beam path

Multifocal, Bifocal, Toric

With the Keratograph 4 you can quickly and precisely measure all data needed for multifocal, bifocal and toric contact lenses. Furthermore the Keratograph 4 software can be linked to fitting programs of various contact lens manufacturers.

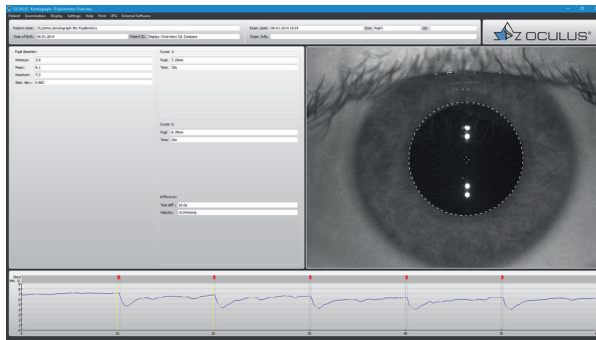

Pupillometry

Using the "Pupillometry" option, the reaction of either pupil can be checked with and without glare. This provides the basis for selecting the proper treatment zone for laser controlled surface ablation, multifocal contact lenses or premium IOLs. The left and right pupil reaction can be compared.

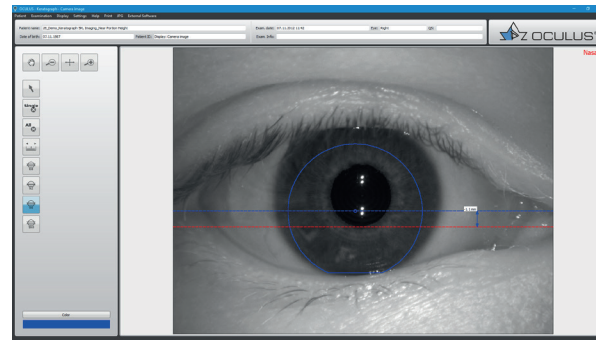

Near-portion Height Measurement

This software precisely simulates the near-portion height of rigid bifocal contact lenses, simplifying the complex fitting process.

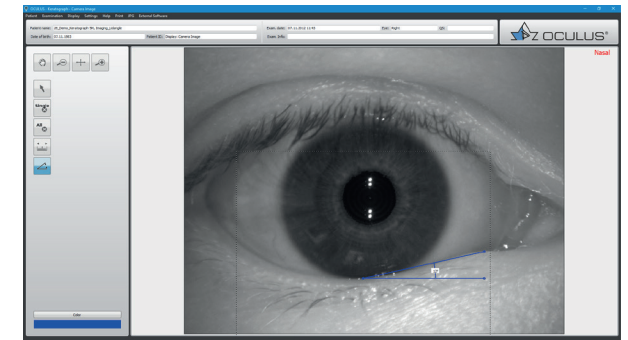

Palpebral Angle Measurement

Measurement of the imaginable angle of the nasal side of the lower eyelid facilitates determination of the expected inclination or stabilization axis when fitting toric contact lenses.

Save time and money by giving this information to the contact lens manufacturer when placing your order.

TF-Scan Makes the Tear Film Visible

This software shows the quality and quantity of the tear film: Patient consultation made easy

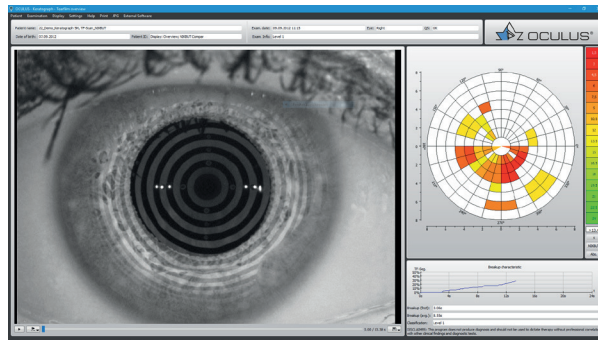

Tear Film Quality (NIK BUT)

Patients and contact lens wearers with dry eye syndrome require a careful examination of the tear film. Only an intact tear film guarantees contact lens wearing comfort. The Keratograph 4 measures the tear film break-up time non-invasively (quality assessment). You can show your patient their individual tear film quality using the colour maps. In addition, you can take a further non-invasive measurement to determine the amount of tear film (tear film quantity).

The Keratograph 4 determines the break-up time using the NIKBUT procedure (non-invasive Keratograph break-up time).

Changes in the projected Placido rings (displacement of the ring edges) give an indication of the break-up time of the tear film on the cornea.

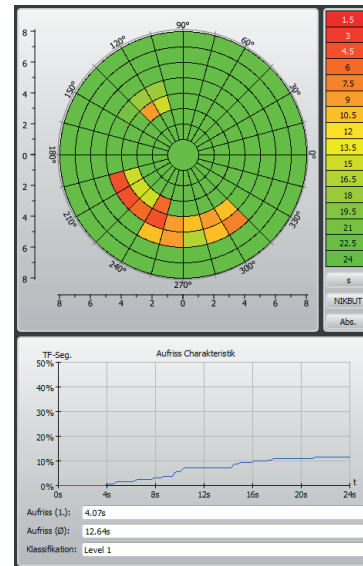

The Tear Map shows the affected areas: The respective break-up time is graphically illustrated for each segment in seconds and according to the principle of a traffic light.

The graph shows the percentage of area affected during the measuring period.

- green = stable tear film
- yellow = borderline tear film
- red = unstable tear film

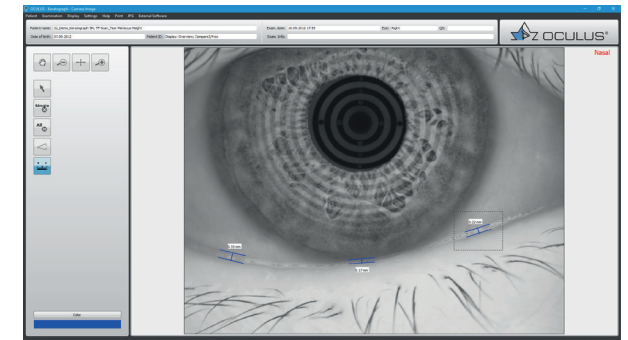

Tear Meniscus Height

Never has a precise measurement been so easy. You can evaluate the course of the tear meniscus along the eyelid using the infrared illumination and precisely measure the tear meniscus height with the built-in ruler. Different magnification levels facilitate measurement, and the resulting value is automatically saved in the patient file.

OxiMap®

Visualizing the oxygen transmissibility of soft lenses

The cornea needs oxygen, and a good oxygen supply is fundamental for comfortable contact lens wear. New materials used for soft contact lenses offer excellent oxygen transmissibility. This can be shown with the OxiMap® display. You can easily show these colour maps to your patients and help them choose better contact lenses.

How Much Oxygen Really Reaches the Cornea?

Until now, oxygen transmissibility values were always quoted for the centre of a -3.00 D contact lens. The OxiMap® now shows oxygen transmissibility as a function not only of lens material but also of thickness. The OxiMap® is available for the most frequently sold spherical soft contact lenses. This tool assists you in finding the most suitable contact lens for your patient.

Plain and Comprehensive Visualization Assures Patient Loyalty!

Contact lenses act as a potential barrier to oxygen transport even when the eyes are open. Long-term wearing comfort can only be guaranteed with a sufficient oxygen supply. The diagram shows the oxygen transmissibility of contact lenses on a colour scale representing international recommendations for daily, extended and continuous wear.

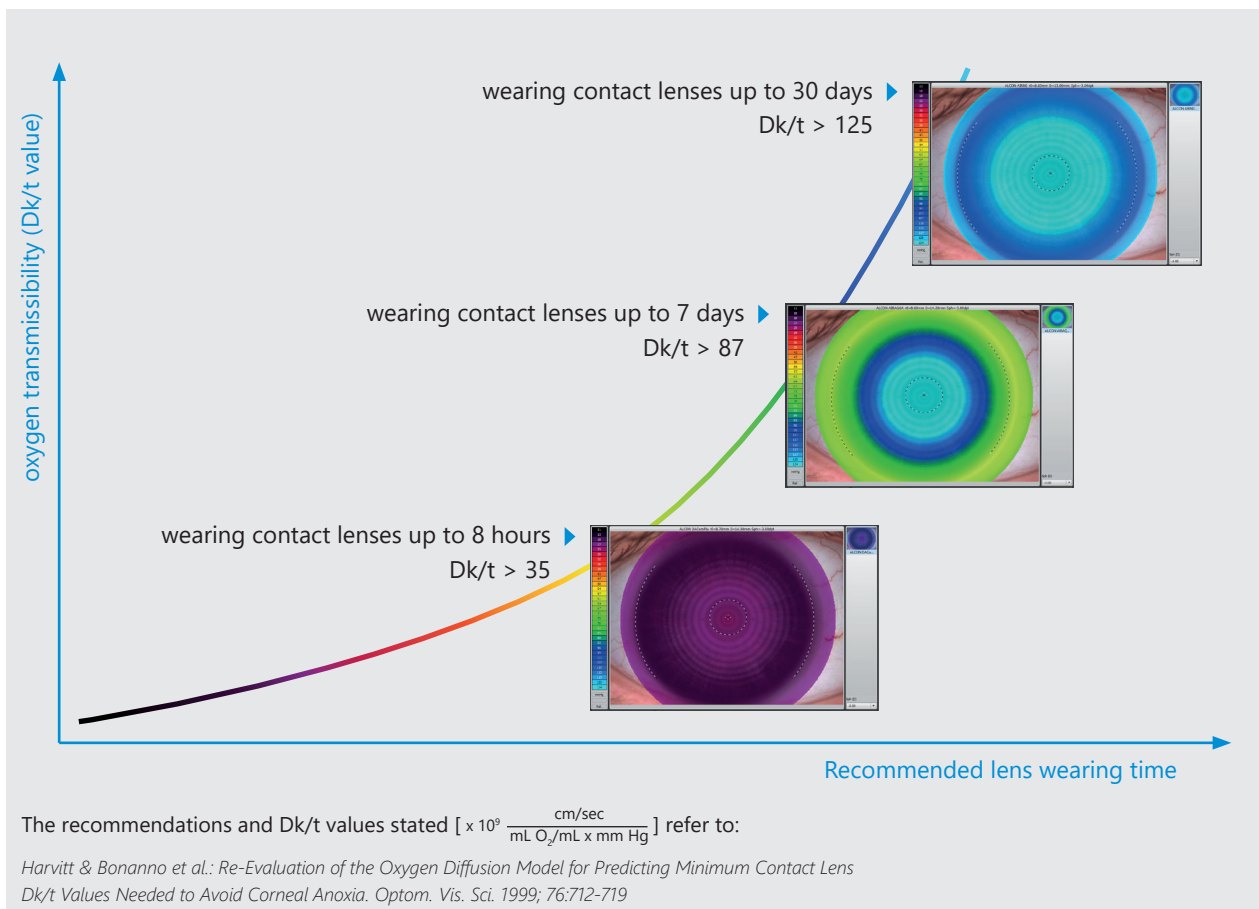

OCULUS Keratograph 4

Technical Data

General information	
Measurement range	3–38 mm, 9–99 D
Precision	± 0.1 D
Reproducibility	+/-0.1 D
Number of rings	22
Working distance	80 mm
Number of measuring points	22000
Camera	Digital CCD camera
Light source	Placido illumination: red diodes (650 nm) Imaging illumination: blue diodes (465 nm, UV-free) Pupillometry illumination: infrared diodes (880 nm)
Technical specifications	
Dimensions (WxDxH)	275 x 320 - 400 x 490 - 517mm (10.8 x 12.6 - 15.7 x 19.3 - 20.4 in)
Weight	11,7 lbs
Max. power consumption	18 W
Voltage	90 - 264 V AC
Frequency	100-240VAC, 47 - 63 Hz
Recommended computer specifications	CPU Intel® Core™ i5-7600, 1 TB HDD, 8 GB memory, Windows® 10Pro

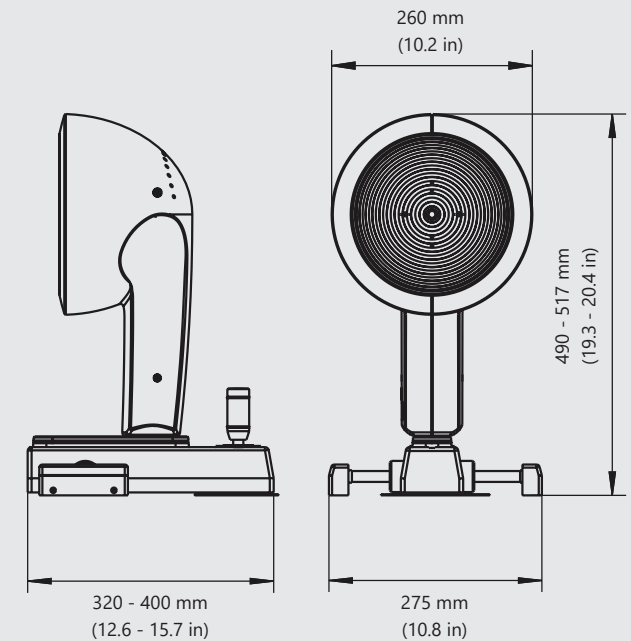

WWW.OCULUS.DE



OCULUS is certified by TÜV according to
DIN EN ISO 13485 MDSAP

OCULUS Optikgeräte GmbH
Postfach • 35549 Wetzlar • GERMANY
Tel. +49 641 2005-0 • Fax +49 641 2005-295
Email: export@oculus.de • www.oculus.de

Find your local OCULUS representative on our website.

The availability of products and features may vary by country.
OCULUS reserves the right to change product specifications and
design. All information is valid at the time of printing (09/21).

OC/1895/WZ/EN
P/70670/EN